

Submittal WHU09DHA21S

9,000 BTU Horizontal Duct

Job Name _____
Location _____
Engineer _____
Submitted To _____
Submitted By _____
Reference _____

Date _____
Approval _____
Construction _____
Unit No _____
Drawing No _____

FEATURES

- Wired Remote Controller Included
- Cool/Dry/Heat/Fan/Auto Modes
- Weekly & 24 Hour Timer
- Auto Restart
- Cold Air Prevention
- °C & °F convertible
- Optional IR Remote & Receiver

SYSTEM COMPONENTS

Indoor Unit Model Number WHU09DHA21S
 Nominal Capacity - BTU/h 9000

ELECTRICAL

Voltage/Phase/Frequency 208 / 230V, 1-Phase, 60Hz
 Voltage Range - V 198 - 253
 Rated Current (Cooling) - A 3.7
 Rated Current (Heating) - A 3.9
 Rated Input Power (Cooling) - W 750
 Min - Max Input Power (Cooling) - W 390 - 994
 Rated Input Power (Heating) - W 908
 Min - Max Input Power (Heating) - W 229 - 1043

CAPACITIES

Cooling Capacity - BTU/h 9000
 Cooling Capacity Range - BTU/h 4850 - 11600
 Heating Capacity - BTU/h 10000
 Heating Capacity Range - BTU/h 4500 - 10000

FAN SPEEDS

Indoor Airflow Rate (H/M/L) - CFM 309/259/208
 Indoor Airflow Rate (H/M/L) - m³/h 520/435/350
 Static Pressure Range - WG(Pa) 0 to 0.2 (0 to 50)

SOUND PRESSURE

Sound Pressure Level Indoor (H/M/L) - dB(A) 35/33/32- Cooling & Heating

INDOOR TEMPERATURE SETTING RANGE

Cooling, - °F (°C) 61°F to 86°F (16°C to 30°C)
 Heating, - °F (°C) 61°F to 86°F (16°C to 30°C)
 Moisture Removal pints/h (L/h) 1.7 (0.8)

LINESET REQUIREMENTS

Connection Pipe Diameter - Liquid (Flare) - in (mm) Ø1/4 (Ø6.35)
 Connection Pipe Diameter - Gas (Flare) - in (mm) Ø3/8 (Ø9.52)

NET DIMENSIONS & WEIGHTS

Indoor Unit Net Dimensions (W x H x D) - in	7-1/2 x 35-7/8 x 17-5/8
Indoor Unit Net Dimensions (W x H x D) - mm	190 x 910 x 447
Indoor Unit Gross Dimensions (W x H x D) - in	11-1/4 x 42-1/2 x 22-1/4
Indoor Unit Gross Dimensions (W x H x D) - mm	285 x 1,080 x 565
Indoor Unit - Net Weight - lbs (kg)	39.7 (18)
Indoor Unit - Gross Weight - lbs (kg)	46.3 (21)

ACCESSORIES

WH-AIRDH1	IR Receiver
4175260*	Wireless Remote Controller
WWRCU	Wired Remote Controller
FJ-IR-WIFI-1NA*	Intesis IR WiFi Module
BP101WA*	Cielo Breez Plus

*Requires IR Receiver

WARRANTY



7 Year Compressor, 5 Year Parts Warranty



Note: Specifications are subject to change without notice. Specifications are based on the following conditions:
 Cooling: Indoor temperature of 80°F (26.7°C) DB/67°F (19.4°C) WB, and outdoor temperature of 95°F (35°C) DB/75°F (23.9°C) WB. Heating: Indoor temperature of 70°F (21.1°C) DB/60°F (15.6°C) WB, and outdoor temperature of 47°F (8.3°C) DB/43°F (6.1°C) WB. Pipe length: 25ft. (7.5m), Height difference: 0ft. (0m) (Outdoor unit – indoor unit).

DIMENSIONS

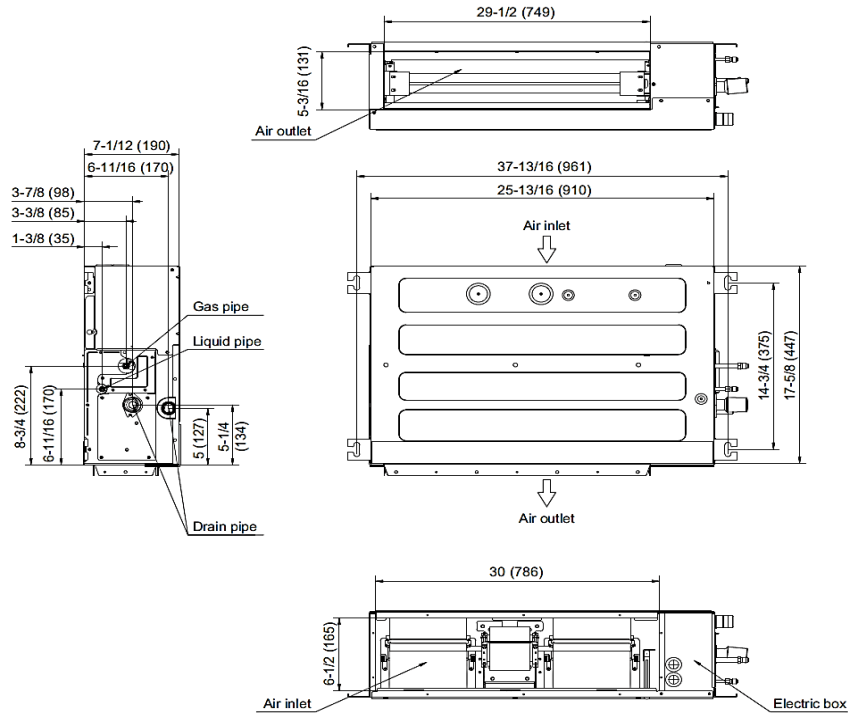
Unit: In. (mm)



 and WESTINGHOUSE are trademarks of Westinghouse Electric Corporation. All Rights Reserved.